

NEW

Available in 300W or 1000W Power Levels

Multi-Functional Front Panel Display and Built-In USB

TDK-Lambda SFL Series

**Programmable DC Electronic Loads
Half-Rack 3U 300W / Full-Rack 3U 1000W**

Advanced Features Built-In

- Stable High Speed Current Control (No Dynamic Overshoot/Oscillation) with High Slew Rate (Up to 30A/us) •
 - Low Voltage Operation with No Turn-On Delay •
 - Seven Operating Modes (CC, CR, CP, CV, EXT, Short, CV+Climit) •
 - Large 3.5" Color LCD Screen • Load Terminals on Front and Rear Panel •
- Dynamic (Time / Frequency) Mode (Pulsating Load) • Sequence Operation (Waveform Generation) •
 - Sweep Mode Test Function (V/I, OCP, OPP) •
 - Built-In Memory Function (store/recall up to eight memory settings) •
 - Parallel Operation (up to ten units) • Multi-Channel Triggering (up to ten units) •
- Built-In Protection & Alarms (Current Limit, Power Limit, OTP, OVP, Reverse Connection) •
 - Optional IEEE (w/DIDO) Interface • Optional Ripple Measurement Interface •



TDK-Lambda
Trusted · Innovative · Reliable

Overall Product Description

Overview:

- The **SFL DC Electronic Load Series** is multi-functional programmable DC Electronic load series that offers power levels of **300W** (3U Half Rack) and **1kW** (3U Full-Rack) with high speed response and stable operation at low voltage and can be used as an electronic load for the design, evaluation and manufacture of regulated DC power supplies, fuel cells, solar cells, batteries and components.
- This DC Electronic Load Series offers seven **Load Operating Modes** (*CC, CR, CP, CV, EXT, CV+Climit*) that allow the user to connect and test products under various different operating conditions in design/development evaluation and production testing environments.
- There are two different Dynamic operating modes offered to the user that include **Dynamic Frequency Mode** (which allows the user to switch the load between two different settings for a single pulse or repeating pulse profile) and **Dynamic Time Mode** (which allows the user to program up to 16 load settings which can be programmed for a repeating pulse profile). Both modes also provide a rear panel **TRIG OUT** function for waveform scope viewing or for synchronization with other test equipment.
- A **Sequence** function is built-in where simple/complex waveforms can be created (up to 1024 time steps) using Excel-base control software and Digital Interface communication (USB or IEEE) and a **Sweep Mode** feature is also available which allows for product testing where devices/products require test sweeps in CR mode (*Sweep R*) for V-I characteristic testing, CC mode (*Sweep C*) for overcurrent protection characteristic testing or CP (*Sweep P*) for overpower protection characteristic testing.
- There is also a **VMode** function that automatically changes the load mode (when voltage is rising or falling) or turns off the load input until the load voltage reaches a set value, **on-board memory** for storage/recall of up to eight operational settings and a rear panel **Remote Sense** selection switch and connection ports for connection and voltage measurement across the test device.
- Model functions can be set up via the large 3.5" color LCD front panel display (which has oscilloscope-like function keys on the vertical and horizontal borders). Change second sentence: Using these keys in combination with the four embedded operation screens (**MAIN, MENU, SYSTEM** and **MEMORY**) allows for adjustment, setup, store and recall of the load operating parameters. These model functions are also accessible via the built-in **USB** interface or the optional **IEEE** Interface.
- Higher power DC load systems (of up to 10kW) are achievable using a Master-Slave unit arrangement and a simple parallel cable connection from unit-to-unit, with all system control and monitor performed through the Master unit (for easy user interfacing).
- Multi-channel synchronous operation (with triggering) is also available and allows multiple DC electronic loads to be connected to separate devices by using the same parallel cable connection from unit-to-unit. Synchronized load ON/OFF and Dynamic operation are featured in a Master-Slave configuration with up to ten units total (up to 10kW total).
- Optional interfaces offered include the **IEEE** Interface (with a built-in **DIDO** Interface) and the Ripple Measurement Module (**R**) Interface. The IEEE Interface is 488.1 compliant with Instrument Software Drivers available for use. The **DIDO** Interface allows for remote interfacing with PLC controllers and includes isolated control and status of load ON/OFF, Range setting, Alarm Detection/Clear and Sweep Function Pass/Fail status.
- The **R** (Ripple Measurement) Interface is used for measuring Output voltage ripple and noise and can separate and measure and display line frequency, switching voltage or noise voltage ripple (with 100MHz or 20MHz bandwidth) using the Filter function and can also measure and display the DC voltage, Power or combined DC and ripple/noise voltage added.
- Models are available in **300W** and **1000W** power levels with Output voltages of **120V** (60A and 180A) and **500V** (18A and 36A) and are powered from a universal single-phase AC input (85~264VAC, 47~63Hz).

Key Features:

- **Low and High Load Power Rating::**
Half-Rack 300W and Full-Rack 1kW power levels
- **Low and High Load Voltage Rating:**
120V (60A or 180A) and 500V (12A or 36A)
- **Seven Load Operating Modes:** CC, CR, CP, CV, EXT, Short, CV+Climit
- **Stable High Speed Current Control**
(No Dynamic Overshoot/Oscillation)
- **Low Voltage Operation with No Turn-On Delay**
- **Variable Slew Rate Control:** Up to 30A/us
- **Dynamic (Frequency or Time) Mode Operation:**
For simple pulse profile operation
- **Sequence Mode:** For complex waveform generation
- **Sweep Mode Test Function w/ Display:** V-I Test, Over-Current Test, Over-Power Test
- **VMode Function:** to set load rising/falling profile
- **Memory Function Built-In:** store/recall up to eight load settings
- **Protection/Alarms:** Current Limit, Power Limit, OTP, OVP, Reverse Connection
- **Parallel Operation:**
up to 10kW (ten units)
- **Multi-Channel Synchronous Operation:**
For separate synchronized unit operation (up to ten units)
- **Large 3.5" color LCD multi-functional viewing screen**
- **Load Terminals:** Front and back of unit (w/ terminal covers). Binding posts on 300W model front panel.
- **Built-In USB Interface**
- **Optional IEEE Interface**
(w/ **DIDO** built-in for PLC interfacing)
- **Optional R (Ripple Measurement) Interface**
(for Output voltage ripple measurements)
- **GUI and Software Instrument Drivers available**
- **Complies with to IEC/EN 61010-1, Ed. 3**
- **Complies with EN61326-1: 2013 (Class A)**
- **Two Year Warranty**

Front View: Key Features (300W Model)

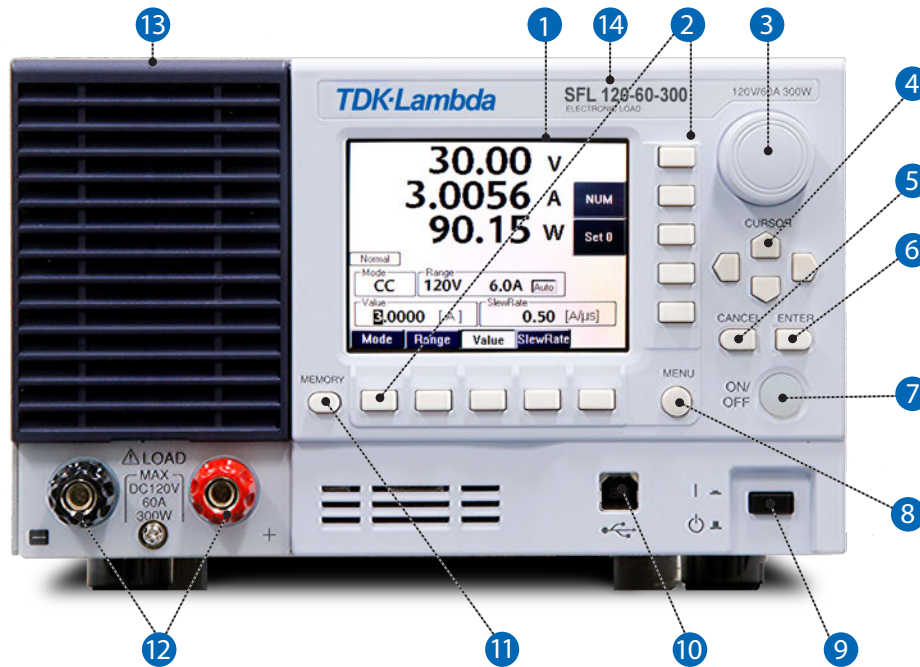

Item	Title	Description
1	Display	Large 3.5" Color LCD display that shows set value, measurement value, etc.
2	Function keys	Allows the user to select items from the Horizontal and Vertical menus
3	MODIFY knob	Continuous rotary knob that increases or decreases a setpoint value
4	CURSOR keys	Up/Down Keys: Angled pushbutton keys that increase or decrease a setpoint value Left/Right Keys: Angled pushbutton keys that select decimal place location
5	CANCEL key	Returns to the previous operating screen (eg. MENU screen to MAIN screen). Allows the user to re-enter data Cancels Remote mode operation (IEEE, USB) and goes to Front Panel Local operation Clears the OVP/Reverse Connection ALARM Stops SEQUENCE operation
6	ENTER key	Pressed to fix an entered numeric value from keypad (eg. load value) or other selection (eg. SYSTEM reset)
7	ON/OFF button	Turns Load Output ON/OFF ; lit GREEN when ON ; unlit when OFF
8	MENU key	Pressing enters into MENU screen or returns to MAIN screen.
9	STANDBY switch	Pressing switches between Standby and Startup state MAIN screen will appear after startup screen and Firmware Version screen
10	USB connector	Type B connector, USB 2.0 compliant interface (USBTMC) for controlling the unit remotely
11	MEMORY key	Pressing enters into MEMORY screen or returns to MAIN screen
12	LOAD terminals	Front Panel Positive and Negative Binding Post terminals for connection to the Device-Under-Test Internally connected to the Rear Panel Positive and Negative load terminals Binding Post terminals for the SFL 300W models only
13	Air Intake slots	Air inlets for product cooling
14	Product Label	Label that identifies product information (Product Series, Voltage/Current/Power, etc.)

Rear View: Key Features (300W Model)



Item	Title	Description
1	MASTER/SLAVE IN/OUT connectors	Connects the optional MASTER/SLAVE connection cable from Master (OUT) to Slave (IN) Used during parallel operation only or Multi-Channel Synchronous operation MASTER/SLAVE terminals referenced to minus load terminal
2	TRIG OUT +/- pins	Trigger signal output Used as the trigger signal when observing the load waveform in Dynamic mode with a scope or when synchronizing with other devices TRIG OUT referenced to Case potential
3	EXTernal Control Input (EXT-IN +/- pins)	Input pins for EXTernal voltage control (Load current proportional to Control Voltage) Control voltage range: 0V to 10V EXT-IN terminals referenced to minus load terminal
4	Remote Sense Input (SENSE +/- pins)	For connecting remote sense cable Remote Sense is enabled when the SENSE selection switch is set to EXT SENSE terminals referenced to minus load terminal
5	EXT/INT Switch	Switch for selecting voltage sense signal Set to EXT when using remote sense cable
6	Current Output Monitor (IMON)	Signal is used when monitoring load current waveform with oscilloscope Analog voltage proportional to load current (dependent on Load Current Range) Current Monitor terminals referenced to minus load terminal
7	LOAD terminals	Rear panel load busbars (with mounting hardware) for connection to the Device-Under-Test Internally connected to the Front Panel Positive and Negative load terminals Busbars with M6 (300W)/M8 (1000W) diameter hole
8	AC Power Inlet	For connecting AC power cord between AC service and SFL DC Electronic Load North American or European AC Input linecord available Single-phase, 85~264VAC, 48-62Hz; 60VA max (300W models)/65VA max (1000W models)
9	AC POWER Switch	AC Input Main Power switch; Switch depressed to I = ON, depressed to O = OFF
10	Ripple Measurement Interface	Optional interface that adds measurement function equivalent to ripple noise measurement using 100MHz oscilloscope recommended by JEITA standard Spiked switching noise and line frequency can be separated and measured Variation found in measurement using oscilloscope can be avoided and measurement time can be reduced Ripple Measurement terminals referenced to minus load terminal
11	Air Outlet slots	Used for heated air exhaust ventilation
12	Optional Interface port	Port for optional communication Interface IEEE Interface with separate DIDO Digital Control Interface DIDO Digital Control used for external control and status monitoring
13	Serial Number Label	Label describing Model # and Serial #
14	CE Mark label	Label indicating product CE mark compliance
15	RoHS label	Label indicating product RoHS compliance

Front Panel Display: Key Features (1000W Model)

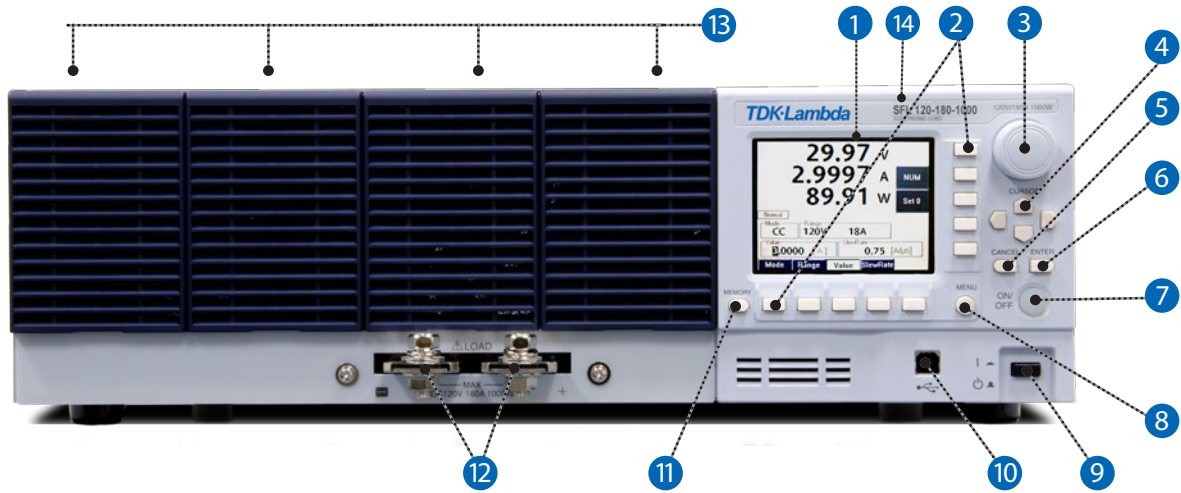

Item	Title	Description
1	Display	Large 3.5" Color LCD display that shows set value, measurement value, etc.
2	FUNCTION Keys	Allows the user to select items from the Horizontal and Vertical menus
3	MODIFY knob	Continuous rotary knob that increases or decreases a setpoint value
4	CURSOR keys	Up/Down Keys: Angled pushbutton keys that increase or decrease a setpoint value Left/Right Keys: Angled pushbutton keys that select decimal place location
5	CANCEL key	Returns to the previous operating screen (eg. MENU screen to MAIN screen) Allows the user to re-enter data Cancels Remote mode operation (IEEE, USB) and goes to Front Panel Local operation Clears the OVP/Reverse Connection ALARM Stops SEQUENCE operation
6	ENTER key	Pressed to fix an entered numeric value from keypad (eg. load value) or other selection (eg. SYSTEM reset)
7	ON/OFF button	Turns Load Output ON/OFF ; lit GREEN when ON ; unlit when OFF
8	MENU key	Pressing enters into MENU screen or returns to MAIN screen
9	STANDBY switch	Pressing switches between Standby and Startup state MAIN screen will appear after startup screen and Firmware Version screen
10	USB connector	Type B connector, USB 2.0 compliant interface (USBTMC) for controlling the unit remotely
11	MEMORY key	Pressing enters into MEMORY screen or returns to MAIN screen
12	LOAD terminals	Front Panel Positive and Negative busbars for connection to the Device-Under-Test Internally connected to the Rear Panel Positive and Negative busbars Busbar terminals used for the SFL 1000W models
13	Air Intake slots	Air inlets for product cooling
14	Product Label	Label that identifies product information (Product Series, Voltage/Current/Power, etc.)

Rear View: Key Features (1000W Model)



Item	Title	Description
1	MASTER/SLAVE IN/OUT connectors	Connects the optional MASTER/SLAVE connection cable from Master (OUT) to Slave (IN) Used during parallel operation only or Multi-Channel Synchronous operation MASTER/SLAVE terminals referenced to minus load terminal
2	TRIG OUT +/- pins	Trigger signal output Used as the trigger signal when observing the load waveform in Dynamic mode with a scope or when synchronizing with other devices TRIG OUT referenced to Case potential
3	EXTernal Control Input (EXT-IN +/- pins)	Input pins for EXTernal voltage control (Load current proportional to Control Voltage) Control voltage range: 0V to 10V EXT-IN terminals referenced to minus load terminal
4	Remote Sense Input (SENSE +/- pins)	For connecting remote sense cable Remote Sense is enabled when the SENSE selection switch is set to EXT SENSE terminals referenced to minus load terminal
5	EXT/INT Switch	Switch for selecting voltage sense signal Set to EXT when using remote sense cable
6	Current Output Monitor (IMON)	Signal is used when monitoring load current waveform with oscilloscope Analog voltage proportional to load current (dependent on Load Current Range) Current Monitor terminals referenced to minus load terminal
7	LOAD terminals	Rear panel load busbars (with mounting hardware) for connection to the Device-Under-Test Internally connected to the Front Panel Positive and Negative load terminals Busbars with M6 (300W)/M8 (1000W) diameter hole
8	AC Power Inlet	For connecting AC power cord between AC service and SFL DC Electronic Load North American or European AC Input linecord available
9	AC POWER Switch	Single-phase, 85~264VAC, 48-62Hz; 60VA max (300W models)/65VA max (1000W models) AC Input Main Power switch; Switch depressed to I = ON, depressed to O = OFF
10	Ripple Measurement Interface	Optional interface that adds measurement function equivalent to ripple noise measurement using 100MHz oscilloscope recommended by JEITA standard Spiked switching noise and line frequency can be separated and measured Variation found in measurement using oscilloscope can be avoided and measurement time can be reduced Ripple Measurement terminals referenced to minus load terminal
11	Air Outlet slots	Used for heated air exhaust ventilation
12	Optional Interface port	Port for optional communication Interface IEEE Interface with separate DIDO Digital Control Interface DIDO Digital Control used for external control and status monitoring
13	Serial Number Label	Label describing Model # and Serial #
14	CE Mark label	Label indicating product CE mark compliance
15	RoHS label	Label indicating product RoHS compliance

Front Panel Display: Key Features (300W/1000W Models)

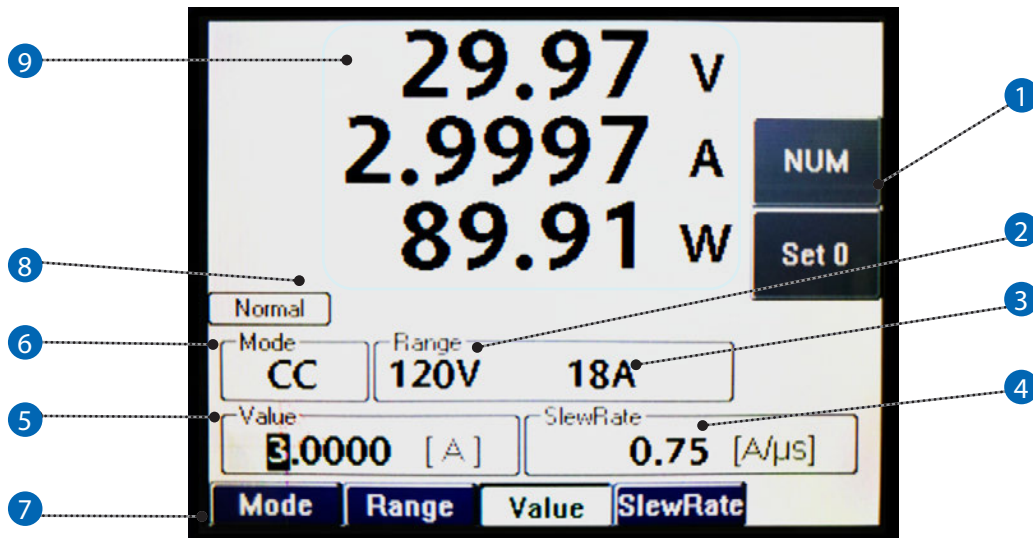

Item	Title	Description
1	Vertical Menu*	Displays detailed settings for a menu item selected on the Horizontal menu Fix by selecting the item using Vertical FUNCTION key(s)
2		Set Value (Voltage Range): Displays the set value of the Voltage range (H/L)
3		Set Value (Current Range): Displays the set value of the Current range (H/M/L)
4		Set Value (SlewRate): Displays the set value of the Slew Rate
5		Set Value (Load): Displays the set value of the load Digits to be set are displayed in reverse contrasting colors
6	Set Value*	Set Value (Load Mode) CC: Constant-Current mode CR: Constant-Resistance mode CV: Constant-Voltage mode CP: Constant-Power mode EX: External Control Mode (CC) ST: Short Mode
7	Horizontal Menu*	Basic setting menu of items displayed on the screen
8	Status Display	Operating Mode, VMode, Master, OCP, OPP
9	Measured Value	Measured values of Voltage, Current and Power. Display order can be changed.

* Vertical menu, Horizontal menu and Set Values displayed on the screen vary according to operating mode or other settings. The figure above is an example of the **Normal** operating mode.

Features

Operating Modes / Load Modes

The SFL DC Electronic Load Series has seven different load operating modes (CC, CR, CV, CP, EXT, SHORT and CV + Climit) with four different operating modes (Normal, Dynamic, Sequence and Sweep) that allows the user to perform a variety (up to seventeen) different types of load tests for DC power supplies, fuel cells, solar cells, batteries and components.

		Load Mode					
		CC	CR	CV CV + Climit	CP	EXT	SHORT
Operating Mode	Normal	●	●	●	●	●	●
	Dynamic	●	●	●	●	N/A	N/A
	Sequence*	●	●	●	●	N/A	N/A
	Sweep	●	●	N/A	●	N/A	N/A

* Sequence Mode uses USB (or IEEE) Interface

Dynamic Overshoot/Oscillation Eliminated

Standard electronic loads may generate load current overshoot and oscillation (during some operating conditions) which can damage connected devices. The SFL Series incorporates high-speed current feedback control to eliminate load current overshoot and oscillation to realize a stable and predictable load waveform during turn-On or Dynamic operation.

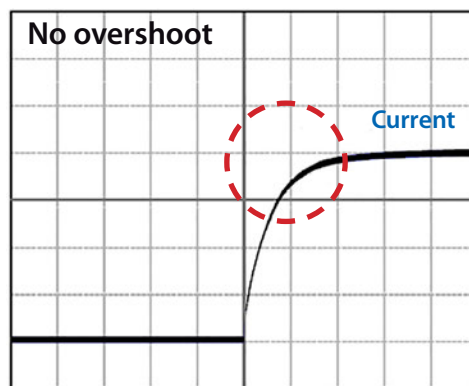

No turn-On overshoot
(DUT Turn-On with Load ON)

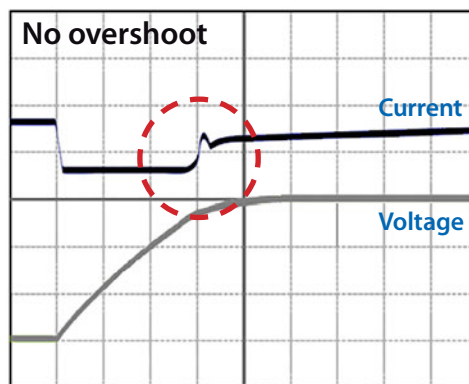

Dynamic Load Change
(No overshoot)

Features

Low Voltage Operation / Rising Load Current Without Turn-On Delay

Some electronic loads may have discontinuity and not allow load current to flow below a minimum operating voltage. Due to low voltage operating optimization the SFL DC Electronic Load Series is able to emulate a resistor where the load current flows and changes linearly from 0V thereby eliminating current cut-off at low operating voltage. This also eliminates any soft-start delay (where load current does not flow until a minimum operating voltage is achieved) and allows low voltage devices to be properly tested.

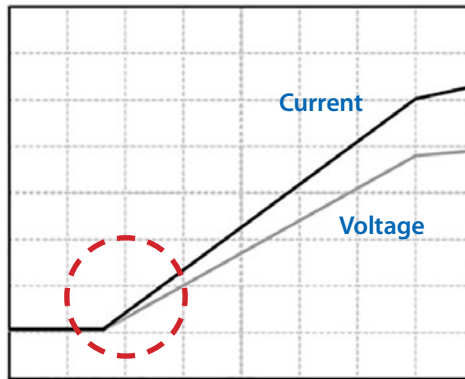

**Low Voltage Operation
with Start-Up from 0V**

Parallel Operation

Parallel operation (via rear panel connection) is achieved by connecting units of the same voltage rating in parallel, connecting a parallel cable from unit-to-unit and setting one unit as the Master unit and all other units as Slave units. Up to nine Slave units can be connected in a system allowing load systems of up to 10kW to be configured.

Load system control is performed by the Master unit where total load system current or power can be set up and displayed on the Master unit front panel.

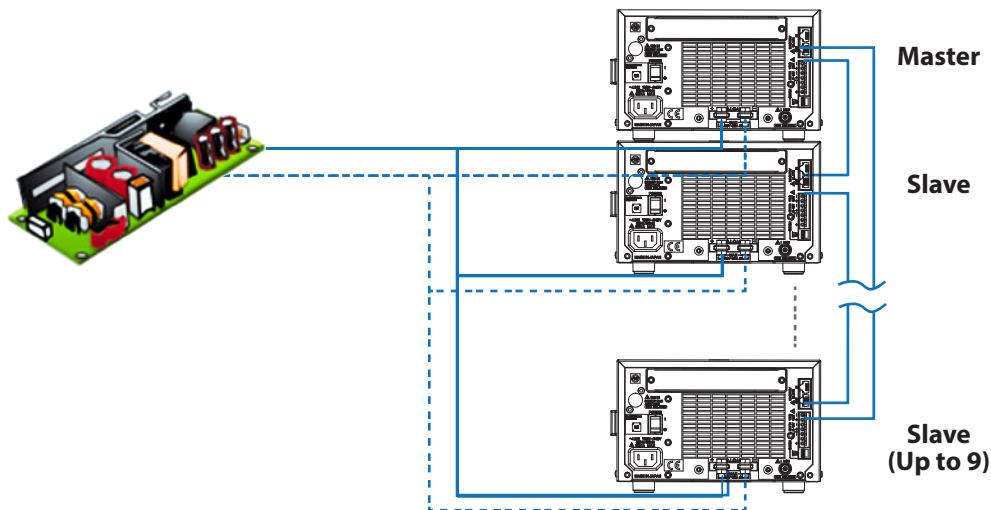

Features

Multi-Channel Synchronous Operation

Multi-channel synchronous operation (with triggering) allows multiple DC electronic loads to be connected to separate devices by using the same parallel cable connection from unit-to-unit. Synchronized load ON/OFF and Dynamic operation are featured in a Master-Slave configuration with up to ten units total (up to 10kW total).

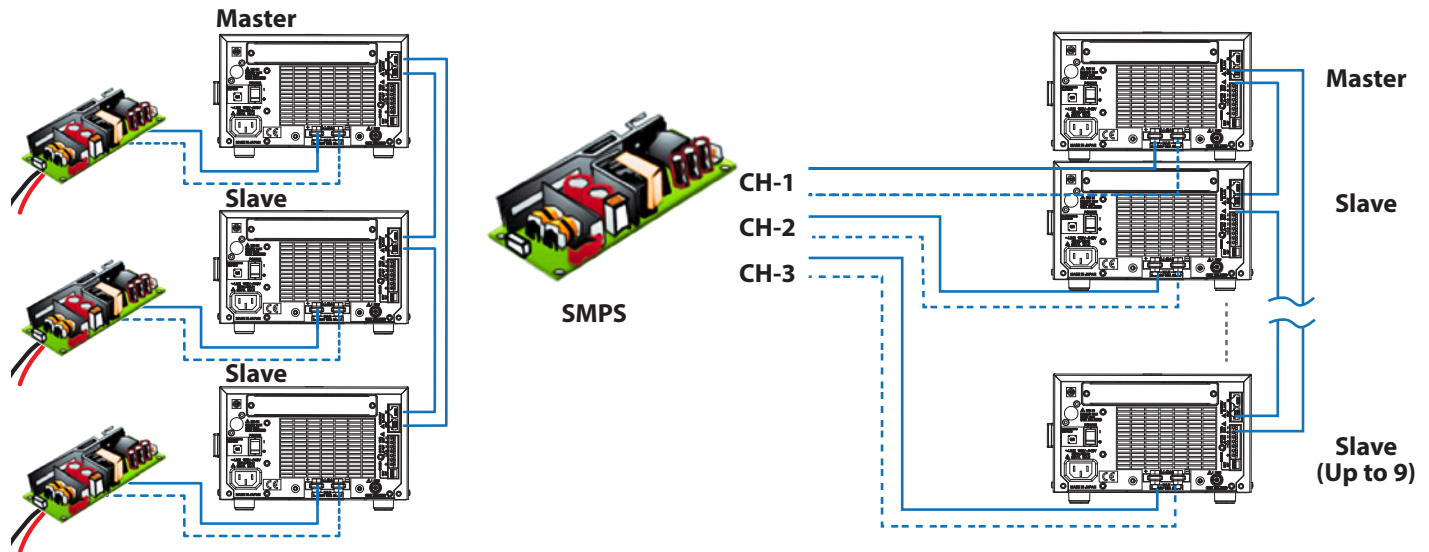

Multiple Device-Under-Test Setup

Single Device-Under-Test Setup (Multi-Output)

Protection Functions and Alarms

Several Protection functions and Alarms are featured including Current Limit (OCP), Power Limit (OPP), Over-Temperature protection (OTP), Over-Voltage protection (OVP) Alarm and Reverse Connection Alarm.

The Current Limit (OCP) has an adjustable limit threshold where the load can be set to either maintain operation at the limit threshold or shut down where the Power Limit (OPP) is set to 100% of rated power and can maintain load operation at the limit threshold or shut down.

	Protection				
	OCP	OPP	OVP ⁽¹⁾	OTP	Reverse Connection ⁽¹⁾
Threshold Limit Adjust	●	Fixed (110% rating)	Fixed	Fixed	●
Operation at Threshold Limit	●	●	N/A	N/A	N/A
Load Shutdown	●	●	●	●	●
Load Current Cutoff	●	●	●	●	N/A
Audible Beep	●	●	●	●	●
Display Alarm	●	●	●	●	●

(1) Remove fault condition from load or load may be damaged

How To Order

SFL DC Electronic Load Series

How to Order - Identification / Accessories

300W Models									
SFL	120	-	60	-	300	-	IEEE	-	R
Series Name	Load Voltage		Load Current		Load Power				
	(0-120V)		(0-60A)		(0-300W)				

1000W Models									
SFL	500	-	36	-	1K	-	IEEE	-	R
Series Name	Load Voltage		Load Current		Load Power				
	(0-500V)		(0-36A)		(0-1000W)				

Programming Interface Options							P/N	P/N
IEEE Interface (488.1 & SCPI compliant)							IEEE	---

Test Interface Options							P/N	P/N
R (Ripple Measurement) Interface							---	R

Models (300W)			
Model	Load Voltage (V)	Load Current (A)	Load Power (W)
SFL 120-60-300	120	60	300
SFL 500-12-300	500	12	300

Models (1000W)			
Model	Load Voltage (V)	Load Current (A)	Load Power (W)
SFL 120-180-1K	120	180	1000
SFL 500-36-1K	500	36	1000

Accessories		Included or Sold Separately	
1	Master/Slave Connection Cable Cable used for Parallel Operation of Multiple Units	P/N: SFL-CBL-PAR	Sold separately
2	Current Monitor (IMON) Cable Cable used for IMON analog signal measurement	P/N: SFL-CBL-IMON	Sold separately
3	EIA Rack-Mount Kit Rack-Mount Kit for SFL-300 (Single/Dual)/SFL-1000 (Single)	P/N: SFL-KIT-RM-EIA	Sold separately
4	Blank Panel, EIA Rack-Mount Blank Panel for Single Unit Rack-Mounting (SFL-300)	P/N: SFL-RM-BP	Sold separately
5	Test Data Sheet - Standard w/Calibration Certificate Test Data Sheet - Standard with Calibration Certificate and Traceability	P/N: SFL-TR-STD-CAL/TR	Sold separately

LOAD CHARACTERISTICS

Ratings		120-60-300	500-12-300	120-180-1K	500-36-1K
Voltage	V	120	500	120	500
Current	A	60	12	180	36
Power, (*1)	W	300	300	1000	1000
Internal Minimum Resistance, (*2)	mΩ	18 or less	100 or less	6 or less	33.3 or less
Load Range, (*2) (*3)	---	1.08V (60A) / 0.54V (30A) / 0.22V (12A)	1.2V (12A) / 0.6V (6A) / 0.28V (2.8A)	1.08V (180A) / 0.54V (90A) / 0.22V (36A)	1.2V (36A) / 0.6V (18A) / 0.28V (8.4A)
Load Range curves					

Operating Mode		120-60-300	500-12-300	120-180-1K	500-36-1K
Normal Mode (Constant Load)					
Load Modes	---	Constant Current (CC) mode: Constant current will flow even if the load terminal voltage is changed			
	---	Constant Resistance (CR) mode: Current proportional to load terminal voltage will flow (resistive load)			
	---	Constant Voltage (CV) mode: Load terminal voltage remains constant even when load current varies			
	---	Constant Power (CP) mode: Current will flow such that load power remains constant			
	---	External Control (EXT) mode: Load current proportional to voltage of external control input terminal will flow			
	---	Short (SHORT) mode: Creates short circuit between load terminals - up to rated current flows or 100% of Current Limit set value			
Dynamic Mode - Frequency (Fluctuating Load)					
Type	---	Frequency: Allows setting waveform Period and Duty Cycle and repeated switching between two load settings. slew Rate is set for each step individually. See User's Manual for more information			
Load Modes	---	CC / CR / CV / CP			
Period Setting/Resolution	---	1us < Period < 2ms (1us resolution) / 20ms < Period < 200ms (10us resolution) / 200ms < Period < 2s (100us resolution) / 2s < Period < 10s (1ms resolution)			
Duty Cycle Setting	%	0% to 100%			
Operation	---	Single (single waveform) or repeat (repeating waveform); TRIGGER OUT feature available			
Dynamic Mode - Time (Fluctuating Load)					
Type	---	Time: Allows setting Time by Step and sequential/repeated switching of up to 16 types of loads conditions. See User's Manual for more information			
Load Modes	---	CC / CR / CV / CP			
Execution Time	---	1us < T < 20ms (1us resolution) / 20ms < T < 200ms (10us resolution) / 200ms < T < 2s (100us resolution) / 2s < T < 20s (1ms resolution) / 20s < T < 60s (10ms resolution)			
Operation	---	Repeat; TRIGGER OUT feature available			
Sweep Mode					
Type	---	Sweep R (V-I Characteristic Test), Sweep C (Overcurrent Characteristic Test), Sweep P (Overpower Characteristic Test)			
Sweep R (V-I Characteristic Test)	---	Current and voltage values are measured while changing the load in a step-wise manner (in CR mode). Resistance value can be finely changed between steps. Measurement values are shown as a graph on front panel display.			
Sweep C (Overcurrent Characteristic Test)	---	Current and voltage values are measured while changing the load in a step-wise manner (in CC mode). Upper/Lower limits of current value can be set (with PASS/FAIL decision function). Measurement values are shown as a graph on front panel display.			
Sweep P (Overpower Characteristic Test)	---	Power and voltage values are measured while changing the load in a step-wise manner (in CP mode). Upper/Lower limits of power value can be set (with PASS/FAIL decision function). Measurement values shown as a graph on front panel display.			
Sequence Operation (Remote Digital Mode Only - IEEE or USB)					
Type	---	Allows user to program a load waveform profile			
Load Modes	---	CC, CR, CV, CP			
Number of Steps	---	1 - 1024			
Step Time	---	1ms - 10minutes (common to all steps)			
Step Time Resolution	---	1ms (1ms to 100ms) / 100ms (100ms - 10minutes)			
Sequence Repetitions	---	1 to 65535 (finite) or ∞			
Control Method	---	IEEE or USB Interface only; Waveform termination via IEEE, USB or CANCEL key of front panel display			
Waveforms available	---	Triangle, Sine or Arc			

Technical Specifications - SFL DC Electronic Load Series

LOAD CHARACTERISTICS

Load Modes			120-60-300	500-12-300	120-180-1K	500-36-1K
Constant Current (CC) Mode						
	Current Range	---	---	---	---	---
Current Setting Range	H	A	0 - 60A	0 - 12A	0 - 180A	0 - 36A
	M	A	0 - 6A	0 - 1.2A	0 - 18A	0 - 3.6A
	L	A	0 - 0.6A	0 - 0.12A	0 - 1.8A	0 - 0.36A
Current Setting Resolution	H	mA	5mA	1mA	15mA	3mA
	M	mA	0.5mA	0.1mA	1.5mA	0.3mA
	L	mA	0.1mA	0.02mA	0.3mA	0.06mA
Current Setting Accuracy, (*4)	H	---	+/- (0.2% of setpoint +25mA+Vin/50kΩ)	+/- (0.2% of setpoint +10mA+Vin/750kΩ)	+/- (0.2% of setpoint +75mA+Vin/16.67kΩ)	+/- (0.2% of setpoint +30mA+Vin/250kΩ)
	M	---	+/- (0.2% of setpoint +12mA+Vin/50kΩ)	+/- (0.2% of setpoint +3mA+Vin/750kΩ)	+/- (0.2% of setpoint +36mA+Vin/16.67kΩ)	+/- (0.2% of setpoint +9mA+Vin/250kΩ)
	L	---	+/- (0.2% of setpoint +6mA+Vin/50kΩ)	+/- (0.2% of setpoint +2mA+Vin/750kΩ)	+/- (0.2% of setpoint +18mA+Vin/16.67kΩ)	+/- (0.2% of setpoint +6mA+Vin/250kΩ)
Slew Rate (Current Range), (*5)	H	A/us	0.2 - 20A/us	0.01 - 1A/us	0.3 - 30A/us	0.03 - 3A/us
	M	A/us	0.02 - 2A/us	0.001 - 0.1A/us	0.03 - 3A/us	0.003 - 0.3A/us
	L	A/us	0.005 - 0.5A/us	0.00025 - 0.025A/us	0.0075 - 0.75A/us	0.00075 - 0.075A/us
Constant Resistance (CR) Mode						
	Current Range	---	L (20V)	L (85V)	L (20V)	L (85V)
Resistance Setting Range	H	S	40.000S - 0.0005S (0.025Ω - 200kΩ)	3.3333S - 0.0004S (0.3Ω - 2.5kΩ)	120.00S - 0.01S (0.0083Ω - 66.667kΩ)	10.0000S - 0.001S (0.1Ω - 833.33kΩ)
	M	S	4.000S - 0.0005S (0.25Ω - 2kΩ)	0.3333S - 0.0004S (3Ω - 25kΩ)	12.000S - 0.001S (0.0833Ω - 666.67kΩ)	1.0000S - 0.0001S (1Ω - 8333.3kΩ)
Resistance Setting Resolution	H	uS (or mS)	4mS	333uS	12mS	1mS
	M	uS (or mS)	400uS	33uS	1.2mS	0.1mS
	---	---	H (120V)	H (500V)	H (120V)	H (500V)
Resistance Setting Range	H	S	13.333S - 0.0016S (0.075Ω - 600kΩ)	1.111S - 0.0001S (0.9Ω - 7kΩ)	40.000S - 0.005S (0.025Ω - 200kΩ)	3.3333S - 0.0004S (0.3Ω - 2.3333kΩ)
	M	S	1.333S - 0.00016S (0.75Ω - 6kΩ)	0.1111S - 0.00001S (9Ω - 70kΩ)	4.0000S - 0.0005S (0.25Ω - 2kΩ)	0.33330S - 0.00004S (3Ω - 23.333kΩ)
Resistance Setting Resolution	H	us/mS	1.33mS	111uS	3.99mS	333uS
	M	uS/mS	133uS	11uS	399uS	33uS
Setting Accuracy, (*4) (*6) (*7)	---	---	+/- (0.5% of Vin/Set Resistance + 0.2% of FS + Vin/50kΩ)	+/- (0.5% of Vin/Set Resistance + 0.2% of FS + Vin/750kΩ)	+/- (0.5% of Vin/Set Resistance + 0.2% of FS + Vin/16.67kΩ)	+/- (0.5% of Vin/Set Resistance + 0.2% of FS + Vin/250kΩ)
Constant Voltage (CV) Mode						
Voltage Setting Range	H	V	0 - 120V	0 - 500V	0 - 120V	0 - 500V
	L	V	0 - 20V	0 - 85V	0 - 20V	0 - 85V
Voltage Setting Resolution	H	mV	10mV	50mV	10mV	50mV
	L	mV	2mV	10mV	2mV	10mV
Voltage Setting Accuracy, (*4)	---	---	+/- (0.1% of setting + 0.1% of FS)			
Response Time	---	---	Fast / Slow			
Constant Power (CP) Mode						
Power Setting Range	H	W	0 - 300W	0 - 300W	0 - 1000W	0 - 1000W
	M	W	0 - 40W	0 - 40W	0 - 120W	0 - 120W
Power Setting Resolution	H	mW	50mW	50mW	167mW	167mW
	M	mW	5mW	5mW	16.7mW	16.7mW
Power Setting Accuracy, (*4)(*7)	---	---	+/- (0.6% of setting + 1.4% of FS + (Vin*Vin)/50kΩ)	+/- (0.6% of setting + 1.4% of FS + (Vin*Vin)/750kΩ)	+/- (0.6% of setting + 1.4% of FS + (Vin*Vin)/16.67kΩ)	+/- (0.6% of setting + 1.4% of FS + (Vin*Vin)/250kΩ)
External Control (EXT) Mode						
Current Setting Range	H	A	0 - 60A	0 - 12A	0 - 180A	0 - 36A
	M	A	0 - 6A	0 - 1.2A	0 - 18A	0 - 3.6A
Current Setting Resolution	H	mA	5mA	1mA	15mA	3mA
	M	mA	0.5mA	0.1mA	1.5mA	0.3mA
Current Setting Accuracy, (*4), (*8)	H	---	+/- (0.2% of setting + 0.5% of FS + (Vin/50kΩ))	+/- (0.2% of setting + 0.5% of FS + (Vin/750kΩ))	+/- (0.2% of setting + 0.5% of FS + (Vin/16.67kΩ))	+/- (0.2% of setting + 0.5% of FS + (Vin/250kΩ))
Slew Rate (Current Range), (*5)	H	A/us	0.2 - 20A/us	0.01 - 1A/us	0.3 - 30A/us	0.03 - 3A/us
Control Voltage	M	A/us	0.02 - 2A/us	0.001 - 0.1A/us	0.03 - 3A/us	0.003 - 0.3A/us
		V	0 - 10V			
Short (SHORT) Mode						
Short Mode Current (max value), (*9)	H	A	60A	12A	180A	36A
Short Mode Current (max value w/ Current Limit Set)	H	A	110% of Current Limit Value (when Current Limit is set)			

Technical Specifications - SFL DC Electronic Load Series

MEASUREMENT CHARACTERISTICS (FP Display)

DC Voltage Measurement (FP Display)			120-60-300	500-12-300	120-180-1K	500-36-1K
Voltage Measurement Range, (*10)	---	---	---	---	---	---
	H	V	0V to 120V	0V to 500V	0V - 120V	0V - 500V
Voltage Measurement Resolution	L	V	0V to 20V	0V to 85V	0V to 20V	0V to 85V
	H	mV	10mV	10mV	10mV	10mV
Voltage Measurement Accuracy, (*4)	L	mV	1mV	1mV	1mV	1mV
	---	---	+/- (0.05% of reading + 0.5% of FS)			
Measurement Time, (*11)	---	ms	approximately 100ms			

DC Current Measurement (FP Display)			120-60-300	500-12-300	120-180-1K	500-36-1K
Current Measurement Range, (*12)	H	A	0 - 60A	0 - 12A	0 - 180A	0 - 36A
	M	A	0 - 6A	0 - 1.2A	0 - 18A	0 - 3.6A
	L	A	0 - 0.6A	0 - 0.12A	0 - 1.8A	0 - 0.36A
Current Measurement Resolution	H	mA	0.5mA	0.5mA	1.5mA	1.5mA
	M	mA	0.1mA	0.1mA	0.3mA	0.3mA
	L	mA	0.1mA	0.1mA	0.3mA	0.3mA
Current Measurement Accuracy, (*4)	H	---	+/- (0.2% of reading + 0.2% of FS)			
	M	---	+/- (0.2% of reading + 0.2% of FS)			
	L	---	+/- (0.2% of reading + 0.5% of FS)			
Measurement Time, (*11)	---	ms	approximately 100ms			

Power Measurement (FP Display)			120-60-300	500-12-300	120-180-1K	500-36-1K
Power Measurement Method	---	---	by calculation (Measured voltage x Measured current)			
Measurement Time, (*11)	---	ms	approximately 200ms			

PROTECTIVE FUNCTIONS (Protection and Alarms)

Current Limit Protection (OCP/Climit)			120-60-300	500-12-300	120-180-1K	500-36-1K
Current Setting Range	Current Range	---	---	---	---	---
	H, M, L	A	0 - 60A	0 - 12A	0 - 180A	0 - 36A
Current Setting Resolution	H	A	0.1A			
	M	mA	10mA			
	L	mA	1mA			
Load Modes	---	---	CC, CR, CV, CP, EXT, SHORT, Dynamic Mode (Frequency, Time), Sweep (R, C, P)			
Current Limit Operation	---	---	Load turns Off and load current is interrupted or load current limited to 110% of the Current Limit set value; user-selectable; Default = Max Value of H range			
			System setting: Enable = Load OFF for Current Limit condition, Disable = Load current limited for Current Limit condition			
			Front panel will display "Over Current" during Current Limit operation along with audible beep When load current is limited, if the current set value drops below the protection value, the unit will return to its original operating state.			

Power Limit Protection (OPP)			120-60-300	500-12-300	120-180-1K	500-36-1K
Rated Power	---	W	300W		1000W	
Power Limit Operation	---	---	Load turns Off and load current is interrupted when rated power is exceeded or load power limited to 110% of the set value; user-selectable; Default = Enabled System setting: Enable = Load OFF, Disable = Power Limit function Front panel will display "Over Power" during limit operation along with audible beep When power limited, if the power falls below the rated power of power range, the unit will return to its original operating state			

Overtemperature Protection (OTP)			120-60-300	500-12-300	120-180-1K	500-36-1K
Overtemperature Operation	---	---	Load turns Off and load current is interrupted Front panel will display "Over Temperature" during overtemperature condition along with audible beep			

Overvoltage Alarm (OVP)			120-60-300	500-12-300	120-180-1K	500-36-1K
Overvoltage Operation	---	---	Load turns Off and load current is interrupted Front panel will display "Over voltage" during overvoltage condition along with audible beep Remove the overvoltage condition and press CANCEL key to clear the alarm.			

Reverse Connection Alarm			120-60-300	500-12-300	120-180-1K	500-36-1K
Reverse Connection Detection Current, (*13)	---	A	-0.6A	-0.15A	-0.6A	-0.15A
Reverse Connection Operation	---	---	Load turns Off Reverse voltage of -0.6V is required for Alarm detection Front panel will display "Reverse connection" during reverse connection condition along with audible beep Remove the reverse connection condition and press CANCEL key to clear the alarm.			

Technical Specifications - SFL DC Electronic Load Series

OTHER FUNCTIONS

Remote Sense (SENSE)			120-60-300	500-12-300	120-180-1K	500-36-1K
Function	--	--	Measures the voltage across any device connected to the load (using external sense cables connected from SENSE +/- to device +/-).			
Selection	--	--	By rear panel switch (SENSE EXT/INT switch). Set to INT when Remote Sense is disabled; Set to EXT when Remote Sense is enabled. +/- sense cabling required from SENSE +/- terminals to test device.			
Connection	--	--	One-touch terminal block (rear panel); Remote Sense signal is referenced to load terminal potential; See User's Manual for more information			

Trigger OUT (TRIG OUT)			120-60-300	500-12-300	120-180-1K	500-36-1K
Function	--	--	Used as a trigger signal when viewing the waveform of Dynamic mode operation or when synchronizing with other devices			
Output	--	--	0V/+4V, pulse			
Output Voltage	--	--	Pulse ; Step 1: +4V (typical), Pulsewidth = Execution time of Step 1; After start of Step 2: 0V (typical); See User's Manual for waveform profile.			
Connection	--	--	One-touch terminal block (rear panel); TRIGGER OUT signal is referenced to case potential; See User's Manual for more information.			

Current Monitor (IMON)			120-60-300	500-12-300	120-180-1K	500-36-1K
Function	--	--	Output signal Used to monitor the load current waveform using an oscilloscope. Output impedance = 50ohms			
Connection	--	--	BNC connector (rear panel); IMON signal is referenced to load terminal potential (common side of IMON terminal (metal shell of BNC) and Negative terminal of load are internally connected).			
Connection Cable	--	--	Optional Current Monitor cable available; terminate cable with 1MegΩ			
	--	Current Range	--	--	--	--
Monitor Measurement Range	H	A	5V / 60A	5V / 12A	5V / 180A	5V / 36A
	M	A	5V / 60A	5V / 12A	5V / 180A	5V / 36A
	L	A	0.2V / 0.6A	0.2V / 0.12A	0.2V / 1.8A	0.2V / 0.36A
Current Measurement Accuracy, (*14)	H	---	+/- (1% of Conv. Volt. + 1% of FS)			
	M	---	+/- (1% of Conv. Volt. + 1% of FS)			
	L	---	+/- (5% of Conv. Volt. + 3% of FS)			
Output Impedance, (*15)	--	Ω	50Ω			

VMode			120-60-300	500-12-300	120-180-1K	500-36-1K
Function	--	--	Automatically changes the load mode in "Voltage Rising" or "Voltage Falling" during operation			
Operating Mode	--	--	Normal mode (constant load)			
	--	--	OFF : Turns off the function, Load Off (H) : Load Off during "Voltage Rising", Load Off (L) : Load Off during "Voltage Falling" CR(H) : Change to CR Mode when "Voltage Rising", CR(L) : Change to CR Mode when "Voltage Falling" CV(H) : Change to CV Mode when "Voltage Rising", CV(L) : Change to CV Mode when "Voltage Falling" CP(H) : Change to CP Mode when "Voltage Rising", CP(L) : Change to CP Mode when "Voltage Falling"			
Selection	--	--	Set using MENU screen (Default = OFF)			
Setting Range	--	--	0.0000 - 120.000	0.0000 - 500.000	0.0000 - 120.000	0.0000 - 500.000

FRONT/REAR PANEL

Front/Rear Panel			120-60-300	500-12-300	120-180-1K	500-36-1K
Control Functions						
3.5" color LCD display	Front	---	Displays Vertical menu, Horizontal menu, Status, Set value(s) and Measured value(s).			
Function keys	Front	---	Allows user to select items from Horizontal menu (5 keys) and Vertical menu (5 keys).			
Modify knob	Front	---	Allows user to enter a numeric value (clockwise = increase value, counter-clockwise = decrease value), Stopping knob rotation sets the value.			
CURSOR keys	Front	---	UP/DOWN keys: increase/decrease numeric value; UP key = increase value, DOWN key = decrease value; Modified value set right after pressing key LEFT/RIGHT keys: set decimal place; LEFT key = move decimal place left, RIGHT key = move decimal place right			
CANCEL key	Front	---	Returns to previous operation. Cancels Remote control and returns to Local operation (IEEE, USB, SEQUENCE operation). Clears the Alarm.			
ENTER key	Front	---	Changes Set value(s)			
ON/OFF key	Front	---	Sets the LOAD ON (key is illuminated and load current flows) or OFF (key is not illuminated and stops the flow of load current)			
MENU key	Front	---	Enters into Menu screen/Returns to Main screen.			
STANDBY switch	Front	---	Switches between Standby and Startup states. Main screen will appear after Startup screen and Version Display screen.			
MEMORY key	Front	---	Enters into Memory screen/Returns to Main screen.			
AC ON/OFF switch	Rear	---	Main AC Power switch. "I" is the ON position. "O" is the OFF position.			

Technical Specifications - SFL DC Electronic Load Series

FRONT/REAR PANEL

Front/Rear Panel

Display Menus			
MENU screen	---	---	Sets basic parameters (Load Mode, Current Limit, Measure, Measure Rate, Master/Slave setting (parallel operation), VMODE setting and VMODE set value). Commonly used for each Load Operating mode. R Interface menu added to Menu screen when installed. Main screen and System screen can be accessed from Menu screen.
MAIN screen	---	---	Sets the load operating mode (Normal, Dynamic (Time), Dynamic (Frequency), SWEEP R, SWEEP C, SWEEP P). R Interface menu added to Menu screen when installed. Memory screen and Menu screen can be accessed from Main screen.
MEMORY screen	---	---	Up to 8 settings can be stored and recalled by number. Settings stored/recalled are operation Mode, Load Mode, Voltage Range, Current Range, Load Set Value and Slew Rate. SStore operation can be performed if LOAD ON or OFF. Recall operation will change the mode to LOAD OFF, if the mode is LOAD ON. After changing to LOAD OFF, the recall function will be performed. Main screen can be accessed from the Memory screen.
SYSTEM screen	---	---	Sets product functions (IEEE address, DIDO control, Range (DIDO) control, PrwOn (Save Settings), LCD Brightness, Screen Color/Language, Firmware Rev, OCP setting, OPP setting, Optional Interface selection, Reset (factory defaults). Main screen can be accessed from the System screen.
Version Memory screen	---	---	Embedded in System screen settings. Displays P/N, S/N, firmware revisions, options installed and calibration date.
Front Panel Button Indications			
ON/OFF key	---	---	Key is illuminated GREEN and load current flows when ON. Key is not illuminated and stops the flow of load current when OFF.
Front Panel Display Indications			
Power Limit (OPP)	---	---	Display reads Over Power during overpower condition. See Protective Functions (Power Limit Protection) for more information.
Over-Temperature (OTP)	---	---	Display reads Over Temperature during an overtemperature condition. See Protective Functions (Overtemperature Protection) for more information.
Over-Voltage Alarm (OVP)	---	---	Display reads Over voltage during an overvoltage condition. See Protective Functions (Overvoltage Alarm) for more information.
Reverse Connection Alarm	---	---	Display reads Reverse connection during a reverse connection condition. See Protective Functions (Reverse Connection Alarm) for more information.

SYSTEM CONFIGURATIONS

Parallel Operation				120-60-300	500-12-300	120-180-1K	500-36-1K
Parallel Operation	---	---	Used to create higher power electronic load. Up to 10 units can be connected in parallel (including the Master unit) for a 10kW system (using Master/Slave Parallel cable(s)). Main unit is Master and all other units are Slave units. Slave units shall have the same voltage rating as the Master unit; 300W and 1kW models can be paralleled. Load ON/OFF and Slew Rate set by Master unit (for all units). Master unit can display total calculated current and total calculated power of parallel configuration. Set resolution power changes depending on the number of units in parallel. Rear panel load terminals shall only be used for load power connections. Current Ranges: H range, M range.				
Current Setting Accuracy	---	---	+/- 3% of Full-Scale (FS) - typical				
	---	---	+/- 7% of Full-Scale (FS) - typical				
Alarm Setting	---	---	If Alarm occurs (Master or Slave unit), 'FP display of Master unit reads" Booster Alarm" and all units in parallel configuration will be switched OFF.				
	---	---	If the Alarm is triggered by a Slave unit, the Alarm must be cleared in both Master and Slave units before normal operation can occur.				
Multi-Channel Synchronization				120-60-300	500-12-300	120-180-1K	500-36-1K
Function	--	--	Used to synchronize separate loads for ON/OFF control and dynamic mode operation. Two to ten units can be connected in a multi-channel synchronous operating scheme (one Master unit and at least one Slave unit) using Master/Slave Parallel cable(s). Main unit is Master and all other units are Slave units. Slave units can have a different voltage rating than the Master unit. Load ON/OFF set by Master unit (for all units). Rear panel load terminals shall only be used for load power connections.				
Alarm Setting	--	--	If Alarm occurs (Master or Slave unit), FP display of that unit reads "Booster Alarm" and unit with the Alarm will be switched OFF.				
	--	--	If Alarm occurs in both Master and Slave units, the Alarm only needs to be cleared in the unit with the Alarm before normal operation can occur for that unit.				

REMOTE ANALOG SIGNALS AND CONTROLS

DIDO Interface (offered with IEEE option)				120-60-300	500-12-300	120-180-1K	500-36-1K
Function	--	--	Optional Interface provided w/ IEEE Interface that is used for external control and monitor (Load ON/OFF control/status, Voltage/Current range setting/status, Alarm Input/Clear and Status, +12VDC power, SWEEP Pass/Fail and User-Defined Output. Enabled/Disabled via System Screen				

Technical Specifications - SFL DC Electronic Load Series

■ REMOTE ANALOG SIGNALS AND CONTROLS (Continued)

DIDO Interface (offered with IEEE option)		120-60-300	500-12-300	120-180-1K	500-36-1K
Control Input (Edge Detected)					
Load ON/OFF, (*16) (*17)	---	---	Optocoupler LED input: L = Optocoupler LED OFF , H = Optocoupler LED ON		
Current Range, (*16) (*17)	---	---	Optocoupler LED input; CUR-RANGE1 (pins 3-4), CUR-RANGE2 (pins 5-6): Edge-Detected LL : Maintain same status, LH : Current Range = L , HL : Current Range = M , HH : Current Range = H Default = Disabled, Use System screen to Enable/Disable (Enables/Disables both Current range and Voltage range)		
Voltage Range, (*16) (*17)	---	---	Optocoupler LED input: L = L range, H = H range; Default = Disabled, Use System screen to Enable/Disable (Enables/Disables both Current range and Voltage range)		
External Alarm, (*16) (*17)	---	---	Optocoupler LED input: L = Alarm OFF , H = Alarm ON		
Protection/Alarm Clear, (*16) (*17)	---	---	Optocoupler LED input: L = Alarm Not Cleared, H = Alarm Cleared		
Status Output					
Load ON/OFF, (*18)	---	---	Optocoupler open-collector output: Open = Load OFF , Closed = Load ON		
Current Range, (*18)	---	---	Optocoupler open-collector output (2 bit) STATUS1 (CUR-RANGE STATUS1) - L range = Closed, M range = Open, H range = Closed STATUS2 (CUR-RANGE STATUS2) - L range = Open, M range = Closed, H range = Closed		
Voltage Range, (*18)	---	---	Optocoupler open-collector output: Open = L range, Closed = H range		
Protection/Alarm Clear, (*18)	---	---	Optocoupler open-collector output: Open = No Alarm Clear, Closed = Alarm Cleared		
User defined output, (*18)	---	---	Optocoupler open-collector output: Open = user-defined, Closed = user-defined; Controlled from IEEE or USB Interface		
SWEEP Decision, (*18)	---	---	Optocoupler open-collector output: Open = PASS SWEEP C/SWEEP P, Closed = FAIL SWEEP C/SWEEP P		
Power Supply Output					
+12VDC Power Supply	---	---	DC Power Supply for DIDO Control/Status signals		
	---	---	Can be used to drive optocoupler LED input, relay input (to drive optocoupler LED) or open-collector output (external series resistor required)		
	---	---	Limited to < 100mA, Referenced to case potential		

■ AC INPUT POWER

Power Input		120-60-300	500-12-300	120-180-1K	500-36-1K
Voltage	VAC	85 - 264VAC (Overvoltage Category II)			
Frequency	Hz	50Hz +/- 2Hz or 60Hz +/- 2Hz			
Power	VA	< 60VA		< 65VA	

■ ENVIRONMENTAL CONDITIONS

Environmental Conditions		120-60-300	500-12-300	120-180-1K	500-36-1K
Operating Environment	---	Indoor use			
Operating Temperature/Humidity	---	0°C to +40°C (+32°F to +104°F), 5% to 85% RH (absolute humidity 1 to 25 g/m3, no condensation)			
Storage Temperature	---	-10°C to +50°C (+14°F to +122°F), 5% to 95% RH (absolute humidity 1 to 29 g/m3, no condensation)			
Altitude	---	Operating: up to 2000m (~6562ft)			

■ MECHANICAL SPECS

Mechanical Specs		120-60-300	500-12-300	120-180-1K	500-36-1K
Cooling	---	Forced air cooling by internal fans with air flow from front to rear (no side ventilation), zero-stackable			
Weight	---	kg (lbs)		approx. 6.5kg (14.3lbs)	
Dimensions (W x H x D)	---	mm (inches)		approx. 13kg (28.6lbs)	
Mounting	---	Benchtop or rack-mount Benchtop using mounting feet. Rack-mount kit available for 300W model (single unit or two unit). See Outline Drawing(s)		Benchtop or rack-mount Benchtop using mounting feet. Rack-mount kit available for 1000W model (single unit). See Outline Drawing(s)	
	---	standard IEC inlet			
DC Output connections	Front Panel	Binding post (Load current < 20A); Internally connected to rear panel load terminals		Terminals with M8 hardware; internally connected to rear panel load terminals	
	Rear Panel	Terminals with M6 hardware; internally connected to front panel load terminals		Terminals with M8 hardware; internally connected to front panel load terminals	
Interface connections	Front Panel	USB Type B (built-in standard)			
	Rear Panel	MASTER/SLAVE connectors: RJ45 type, use Master/Slave Parallel cable TRIG-OUT connector: One-touch terminal block for "+" and "-" connections, AWG#16-AWG#26 (single wire) - See User's Manual EXT-IN connector: One-touch terminal block for "+" and "-" connections, AWG#16-AWG#26 (single wire) - See User's Manual SENSE connector: One-touch terminal block for "+" and "-" connections, AWG#16-AWG#26 (single wire) - See User's Manual IMON port: BNC-type, use IMON cable			

Technical Specifications - SFL DC Electronic Load Series

■ INTERFACES

Interfaces		120-60-300	500-12-300	120-180-1K	500-36-1K
Master/Slave	---	Parallel/Multi-Synchronization connection (from unit-to-unit); RJ45 connector (rear panel), cable length ~ 1m (3.3ft), one cable per unit; referenced to negative load terminal			
TRIGGER-OUT	---	TRIGGER-OUT connection (for Dynamic operation viewing and device synchronization); One-touch terminal block for "+" and "-" connections (rear panel), referenced to case potential.			
EXT-IN	---	EXTERNAL Mode programming connections; One-touch terminal block for "+" and "-" connections (rear panel), referenced to load potential.			
SENSE	---	Remote Sense (for measuring test device voltage); One-touch terminal block for "+" and "-" connections (rear panel), referenced to load potential.			
IMON	---	Current Monitor connection (to monitor load current waveform using scope); BNC-type (rear panel), common side of IMON terminal (metal shell of BNC) and Negative (-) terminal of load are internally connected).			
USB (built-in standard interface)	---	USB2.0 compliant, USBTMC; Type B USB connector (front panel), cable length < 4m, referenced to Chassis potential			
IEEE (optional interface)	---	IEEE 488.1 compliant, Address 1-30 (Default address = 1); IEEE connector with metal backshell (rear panel), cable length < 4m; referenced to Chassis potential			
DIDO (built-in standard w/ IEEE Interface)	---	Optocoupler-based Control/Monitor Interface (provided with IEEE Interface); Two-row 16 position (female-socket) rectangular IDC connector (rear panel), referenced to case potential when using DIDO +12VDC Power Supply.			
R (optional interface)	---	Ripple Measurement connection (for measuring ripple and noise), BNC-type connector (rear panel) with cover, common side of BNC (metal shell) and negative (-) terminal of load are internally connected.			

■ SAFETY

Safety		120-60-300	500-12-300	120-180-1K	500-36-1K
Applicable Standards	---	Complies with EN61010-1:2010, 3rd Edition			
Pollution Degree	---	Pollution Degree II			
Interface Classification	---	AC Input: Hazardous Primary Load Output (front/rear panel), Master/Slave Interface, TRIG-OUT Interface, EXT-IN Interface, SENSE Interface, USB Interface, IEEE Interface, DIDO Interface, R Interface: Hazardous Secondary			
Withstand Voltage	---	AC Input-to-Output terminals/Chassis: 1500VAC for 60 seconds			
Insulation Resistance	---	> 30Megohms between AC Input and Output terminals/Chassis) @ 500VDC			

■ EMC

EMC		120-60-300	500-12-300	120-180-1K	500-36-1K
Applicable Standards, (*19)	---	Complies with EN61326-1: 2013 (Class A)			
Electrostatic Discharge (ESD)	---	EN 61000-4-2:2009 - 2kV/4kV (Contact Discharge), 2kV/4kV/8kV (Air Discharge)			
Fast Transient Burst	---	EN 61000-4-4:2012 - 1kV for I/O Signal and Control Ports / 2kV for AC Power Port			
Lightning Surge Immunity	---	EN 61000-4-5:2006 - 0.5kV/1kV line-to-line and 0.5kV/1kV/2kV line-to-earth (AC Power Port)			
Voltage Dips and Short Term Interruptions	---	EN 61000-4-11:2004 - AC Power Port			
Power Frequency, Magnetic Field	---	EN 61000-4-8:2010 - 30A/m			
Conducted Immunity	---	EN 61000-4-6:2009 - 3V (for I/O Signal and Control Ports / AC Power Port)			
Radiated Immunity	---	EN 61000-4-3:2006 + A1:2008 + A2: 2010 - 1V/m, 3V/m, 10V/m			
Voltage Fluctuations and Flicker	---	EN 61000-3-3:2013			
Conducted Emissions	---	EN 55011 (Group 1, Class A): 0.15MHz - 30MHz			
Radiated Emissions	---	EN 55011 (Group 1, Class A): 30MHz - 1GHz			

■ WARRANTY

Warranty		120-60-300	500-12-300	120-180-1K	500-36-1K
Warranty	ysr	2yrs			

■ OTHER MEASUREMENT CHARACTERISTICS

Ripple Measurement Module Option (FP Display)		Common for All Models			
DC Voltage Measurement					
Voltage Measurement Range	V	+/- 6V	+/- 60V	+/- 500V	
Voltage Measurement Resolution	mV	0.1mV	1.0mV	10.0mV	
Voltage Measurement Autorange	V	-6.0000V to +6.0000V	-60.000V to -5.600V +5.600V to +60.000V	-500.00V to -56.00V +56.00V to +500.00V	
Voltage Measurement Accuracy, (*4)	---	+/- (0.025% of reading + 0.025% of FS)			
Maximum Applied Voltage	V	+/- 500V			
Measurement Time, (*11)	ms	approximately 100ms			
Ripple / Noise Voltage Measurement					
Maximum Input Voltage	V	+/- 3V			
R/N Voltage Measurement Range	mV	300mV	3000mV		
R/N Voltage Measurement Resolution	mV	0.1mV	1.0mV		
R/N Voltage Measurement Accuracy, (*20)	---	+/- (2% of reading + 1% of FS)			
Filter	THRU	---			
	LPF, (*21)	50Hz to 100MHz			
	HPF, (*22)	50Hz to 2kHz			
20 MHz Bandwidth Limit	---	5kHz to 100MHz			
Ripple Ratio, (*23) (*24)	---	50Hz to 20MHz			
Measurement Time, (*11)	ms	0.0% to 50.0% (per 0.5%)			
Power Measurement					
Measurement method, (*25)	---	Input voltage x Load current			
Measurement Time, (*11)	ms	approximately 200ms			

Technical Specifications - SFL DC Electronic Load Series

- (*1) This parameter will vary depending on unit internal temperature and unit operating time.
- (*2) Measured at the rear panel load terminals. This is not a set value in CR mode.
- (*3) The minimum operating voltage varies depending on the current value.
- (*4) At an ambient temperature of +23°C +/- 5°C (+73.4°F +/- 9°F).
- (*5) At rear panel load terminal. Can ONLY be set in CC mode and EXT mode (cannot be set in CR, CP or SHORT mode). In CV mode, this is the response time setting.
- (*6) Vin is valid starting from 1/10V and greater for the selected range. FS is the Full-Scale current of the Current H range.
- (*7) FS is the Full-Scale Power of the Current H range.
- (*8) Accuracy of External Control Mode is only when the control voltage input is 10V.
- (*9) Short-circuit is created across the load terminals.
- (*10) Voltage measurement range changes in accordance with the Voltage setting range selected.
- (*11) This specification does not apply immediately after the Voltage range has changed.
- (*12) Current measurement range changes in accordance with the Current setting range selected.
- (*13) Reverse connection voltage of -0.6V is required for alarm detection.
- (*14) **Conv. Volt.** indicates converted voltage value of "Measurement Current Value x (Current Monitor **FS** / Rated Current)".
- (*15) With a 1MegΩ terminating resistor.
- (*16) H condition indicates that optocoupler LED is ON; L condition indicates that optocoupler LED is OFF.
- (*17) Resistance of 2.4kΩ in series with LED. Applying 5V-12V results in H condition. Ensure that LED input current is less than 4.5mA.
- (*18) Open-collector output. Maximum applied voltage = 30V, Maximum collector current = 10mA
- (*19) Operation in an environment with a strong electro-magnetic field may cause measured value and load setting to be different.
- (*20) In ripple ration of 0% to 10%, In the range of 10kHz to 10MHz, At an ambient temperature of +23°C +/- 5°C (+73.4°F +/- 9°F).
- (*21) LPF = Low Pass Filter
- (*22) HPF = High Pass Filter
- (*23) In the range of 10kHz to 10MHz.
- (*24) Ripple ratio is the ratio of the switching ripple period originating from switching period and time with ripple noise. Measured values of ripple voltage and noise voltage becomes equal at 0.0% setting.
- (*25) Measurement results are shown as absolute values.

NOTES:

Setpoint refers to set value, **reading** refers to reading and **FS** refers to the maximum value in each range.

Specifications indicate values after warm-up time of 30 minutes. Vin is load input voltage.

Values indicated with accuracy in specifications are guaranteed values (guaranteed for warranty period).

Values without accuracy are nominal values or representative values (indicated as typ.).

Outline Drawing, SFL 300W (120V or 500V Models)

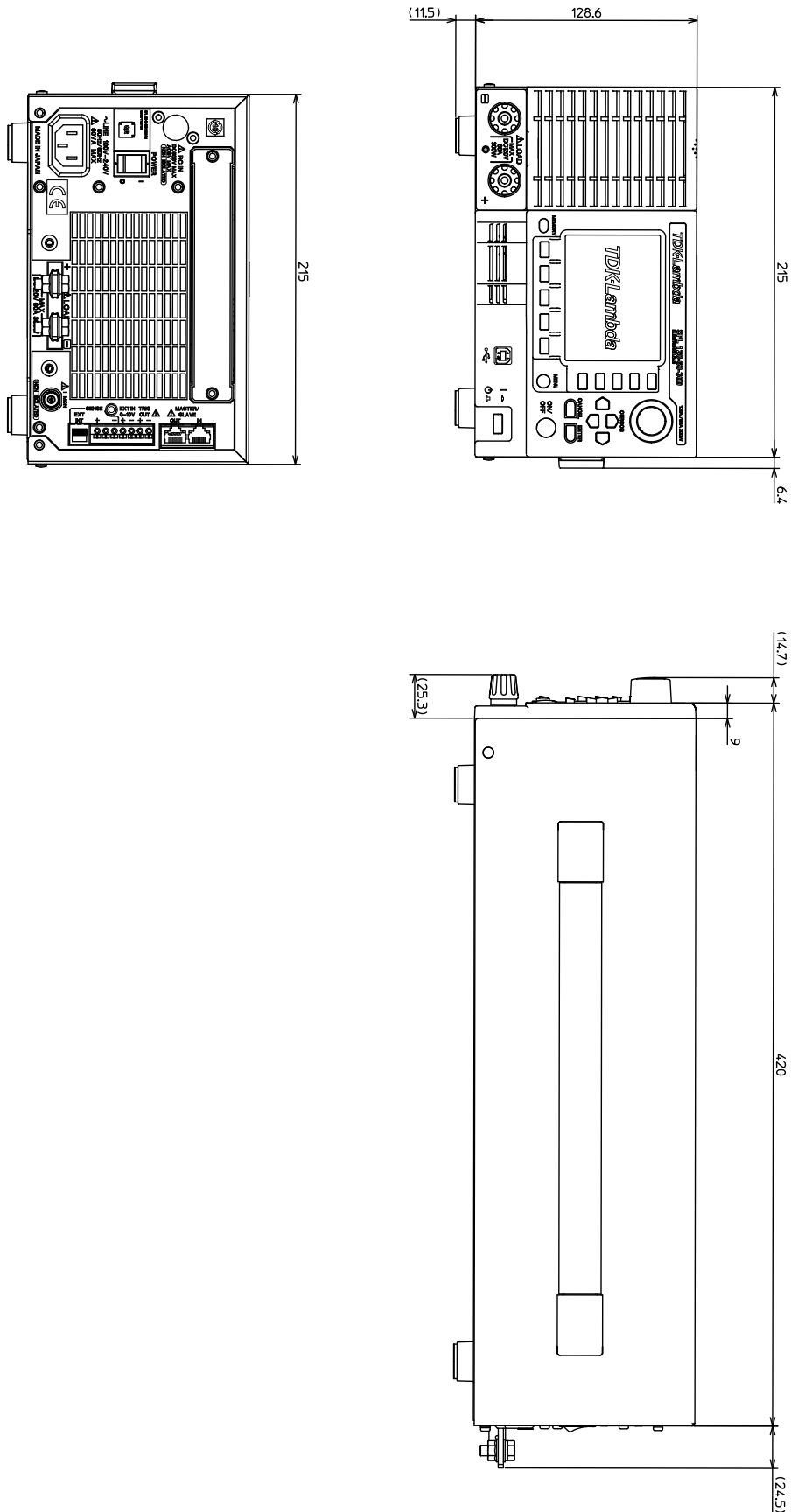

Outline Drawing, SFL 1000W (120V or 500V Models)

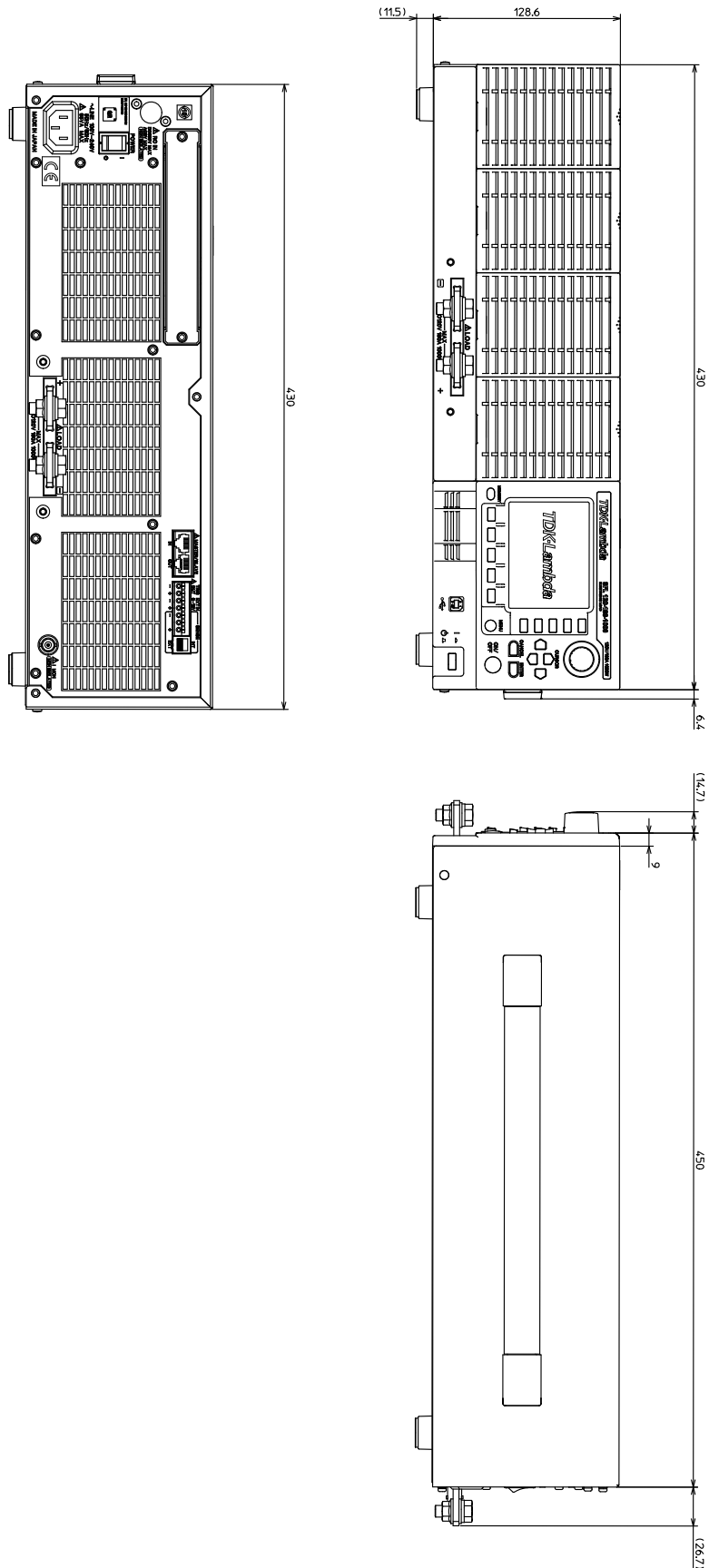

Outline Drawing, SFL 300W, EIA Rack-Mount Kit

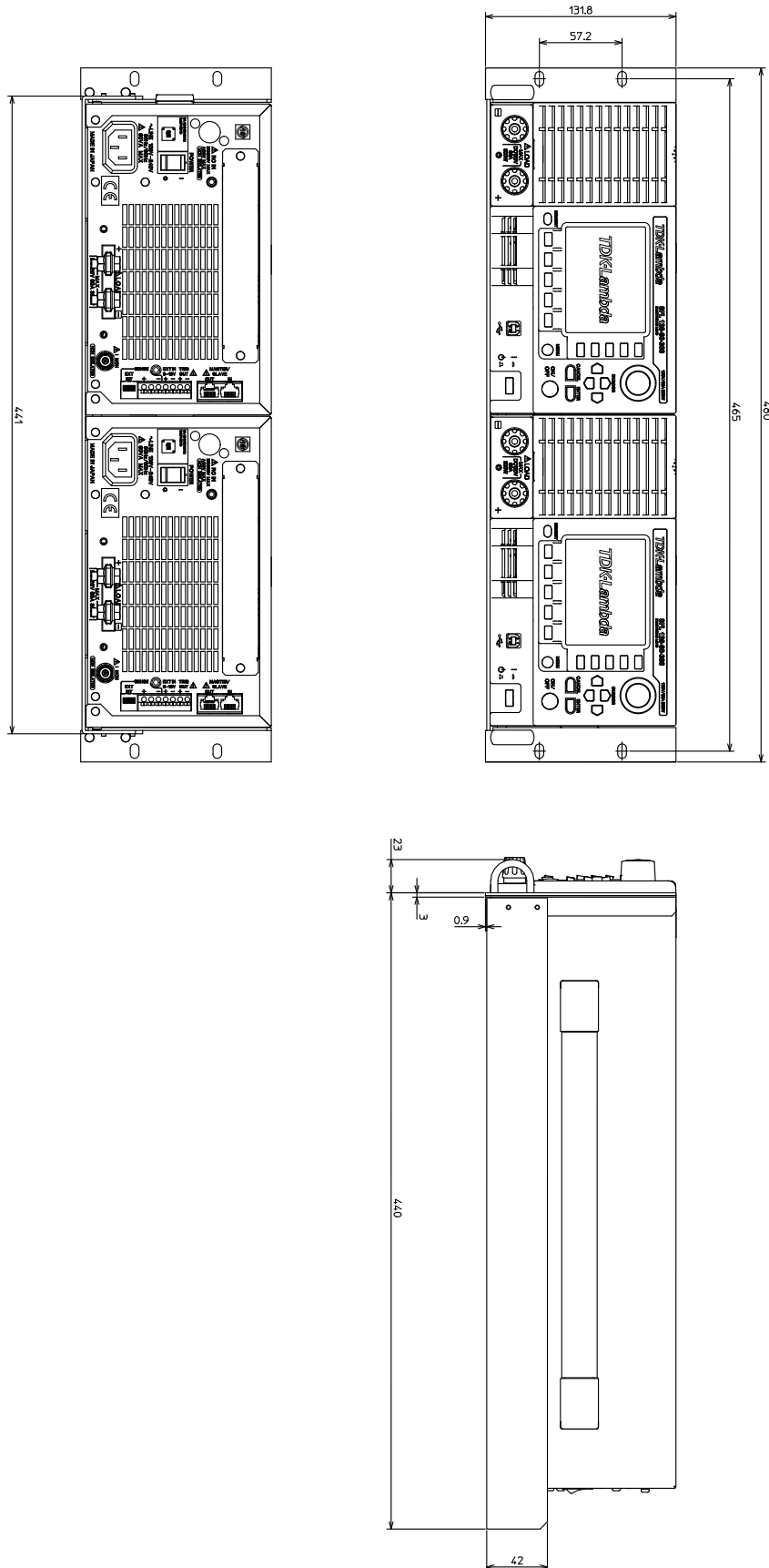

Outline Drawing, SFL 1000W, EIA Rack-Mount Kit

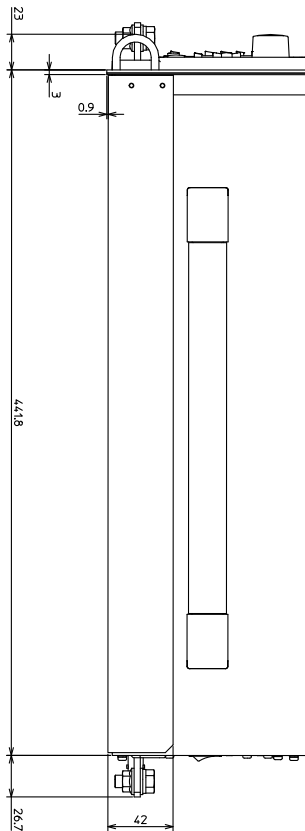
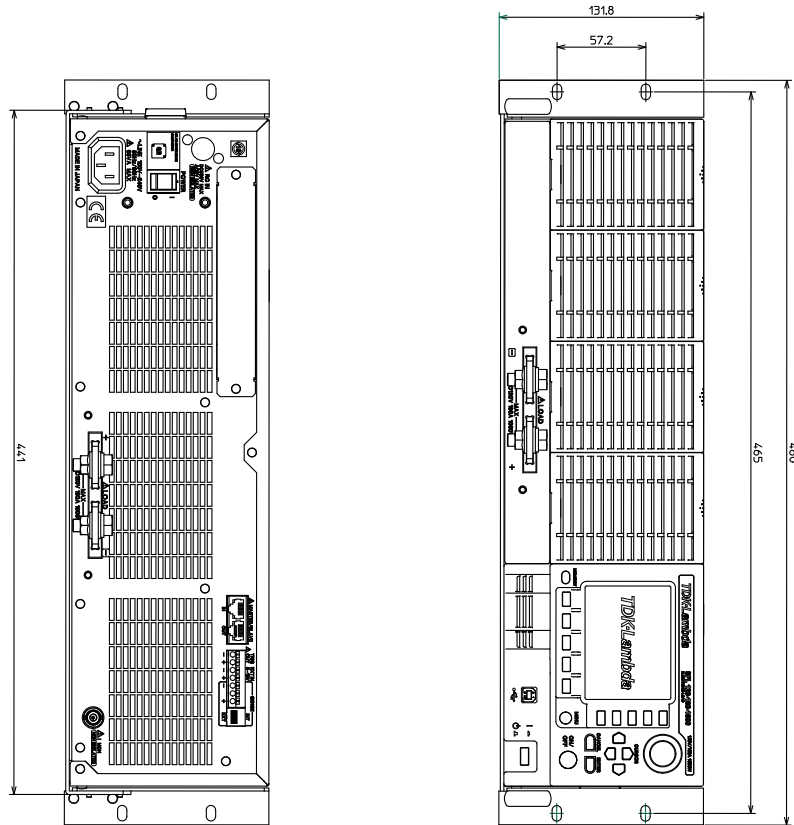

Outline Drawing, SFL 300W, JIS Rack-Mount Kit

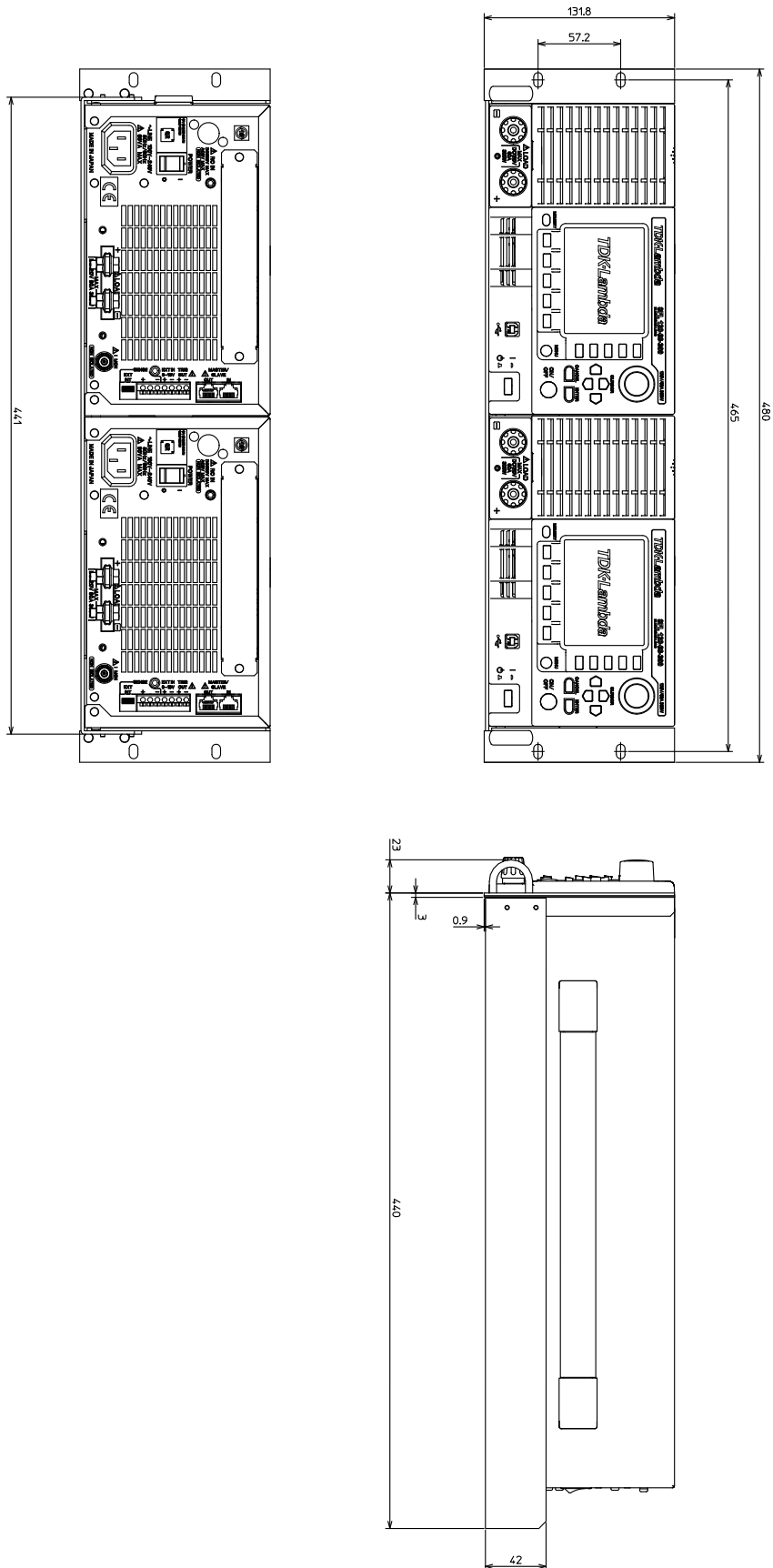

Outline Drawing, SFL 1000W, JIS Rack-Mount Kit

